

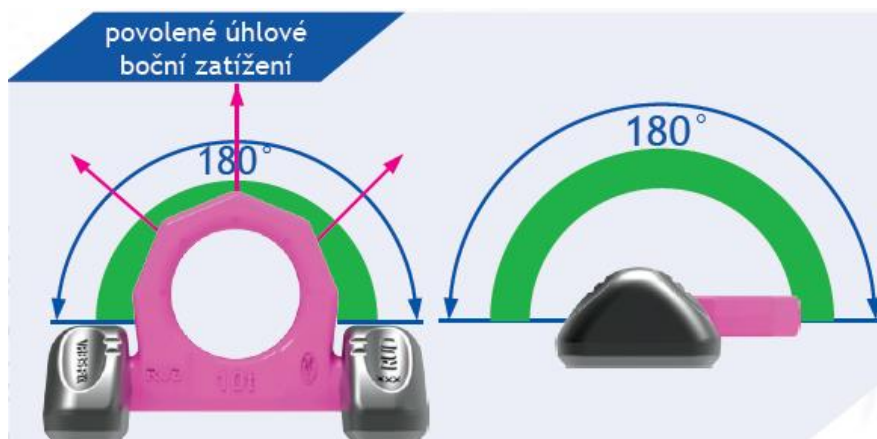















VRBS

navarovací bod, pevný, bez pružiny

- VRBS slouží ke zvedání a manipulaci s břemeny
- **Nosnosti 4 t až 31,5 t** (viz tabulka nosností)
- Plně zatížitelný ve všech směrech
- Oko je sklopné o 180°
- Indikátory opotřebení na vnitřním obvodu oka
- Bezpečnostní faktor 4:1
- Max. rozsah teplotního zatížení
 - bez redukce nosnosti -40° až 200°C
- Max. rozsah teplotního zatížení
 - s redukcí nosnosti až 400°C
- Materiál navařovacího kozlíku 1.0577+N (St 52-3)



Tabulka nosností v tunách – VRBS bez pera

Typ			4t	6,7t	10t	16t	31,5t
Svár Počet pramenů / úhel Beta			HY 4 + a 3 	HY 5,5 + a 3 	HY 6 + a 4 	HY 8,5 + a 4 	HY 18 + a 4 
	1	0°	4	6,7	10	16	31,5
	2	0°	8	13,4	20	32	63
	1	90°	4	6,7	10	16	31,5
	2	90°	8	13,4	20	32	63
	2	0-45°	5,6	9,4	14	22,4	44,1
	2	45-60°	4	6,7	10	16	31,5
	2	asymetrický	4	6,7	10	16	31,5
	3+4	0-45°	8,4	14,1	21	33,6	66,2
	3+4	45-60°	6	10,1	15	24	47,3
	3+4	asymetrický	4	6,7	10	16	31,5

Tabulka rozměrů VRBS bez pera

Typ	WLL [t]	Hmotnost [kg/ks]	T [mm]	A [mm]	B [mm]	C [mm]	D [mm]	E [mm]	F [mm]	Svár
VRBS.4	4	0,8	65	62	14	28	48	135	71	HY 4 + a 3
VRBS.6,7	6,7	1,6	84	88	20	39	60	170	92	HY 5,5 + a 3
VRBS.10	10	3	95	100	22	46	65	195	100	HY 6 + a 4
VRBS.16	16	6,6	127	130	30	57	90	263	134	HY 8,5 + a 4
VRBS.31,5	31,5	15,6	178	160	42	79	130	375	195	HY 18 + a 4

* U některých typů může být závěsné oko již s novým větším tvarem osmiúhelníku

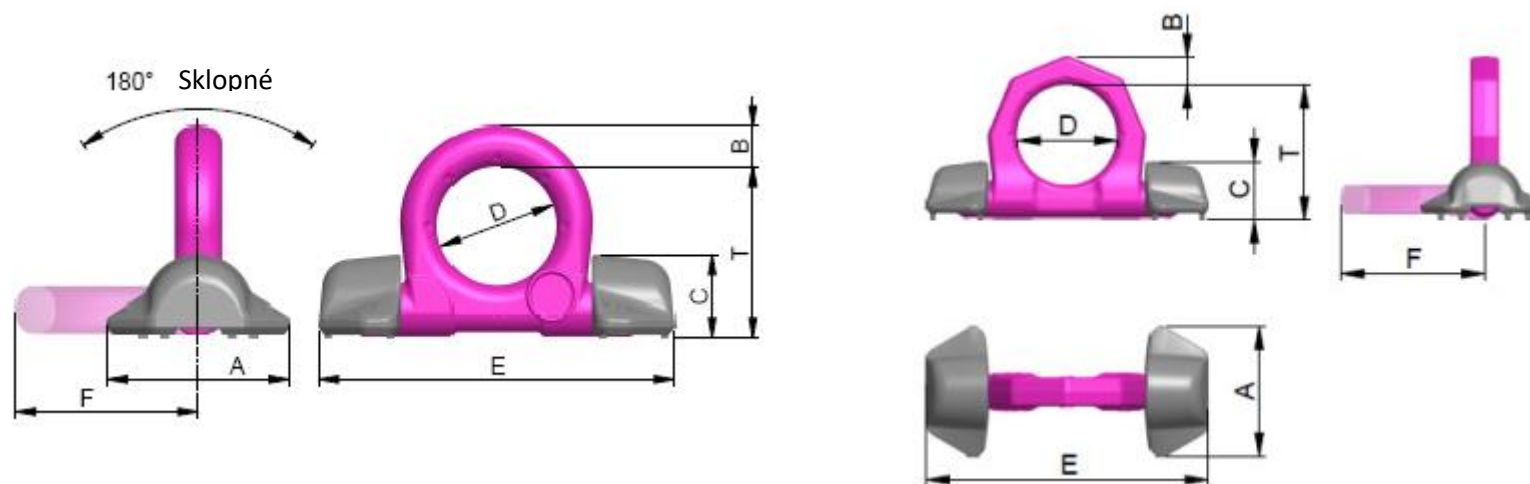

Tabulka rozměrů náhradních navařovacích kozlíků k VRBS bez pera

Typ	WLL [t]	Hmotnost [kg/ks]	T [mm]	A [mm]	C [mm]	F [mm]	Svár
VASK.4	4	0,13	19	62	28	30	HY 4 + a 3
VASK.6,7	6,7	0,34	24	88	39	36	HY 5,5 + a 3
VASK.10	10	0,63	31	100	46	46	HY 6 + a 4
VASK.16	16	1,6	39	130	57	57	HY 8,5 + a 4
VASK.31,5	31,5	3	49	160	78	82	HY 18 + a 4

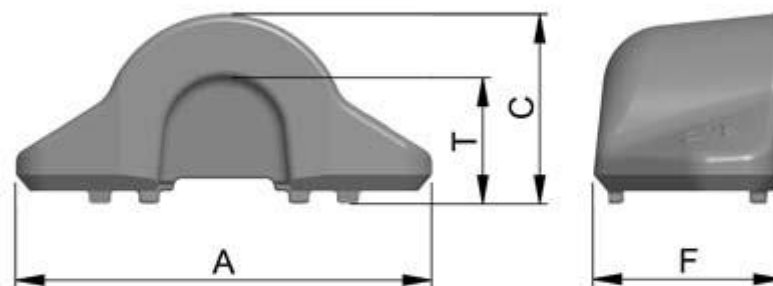

Tabulka rozměrů náhradních ok VRL k VRBS bez pera

Typ	WLL [t]	Hmotnost [kg/ks]	T [mm]	A [mm]	B [mm]	C [mm]	D [mm]	E [mm]	F [mm]	G [mm]
VRL.4	4	0,3	63	105	14	69	48	16	18	77
VRL.6,7	6,7	0,9	82	132	20	91	60	23	22	101
VRL.10	10	1,42	92	150	22	100	65	28	27	106
VRL.FIX.H.16	16	3,23	104	196	30	134	90	32	37	146
VRL.31,5	31,5	8,64	175	292	42	194	130	48	48	215

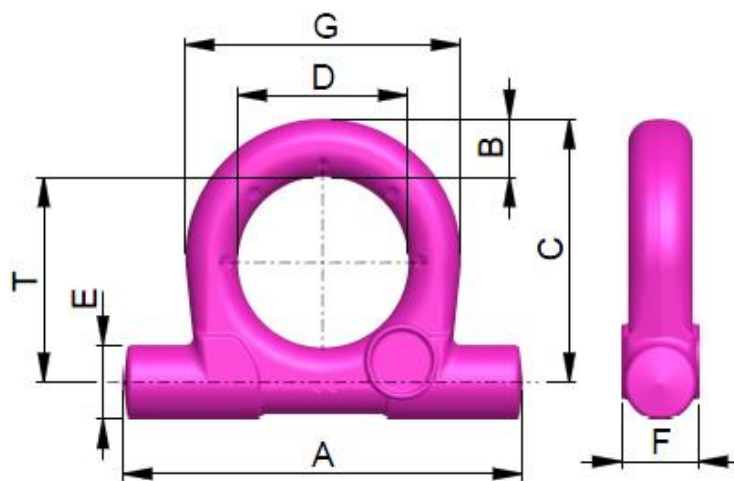

Náhradní oko k VRBS 16t

